

REINER

jetStamp 990



Operating Manual

GB

Inhaltsverzeichnis

I Your jetStamp	5
1.1 Operating elements.....	6
1.2 Display and button function.....	8
1.3 Main menu.....	9
1.3.1 Cartridge change	10
1.3.2 Device lock	10
1.3.3 Bluetooth	10
1.3.4 Date/time	10
1.3.5 Numbering machine	11
1.3.6 Settings	11
1.3.7 Model version	12
II Important notes	13
2.1 Rechargeable batteries.....	13
III Your safety	14
3.1 Safety, description.....	14
3.2 Safety notes on rechargeable batteries.....	15
3.3 Safety notes.....	16
3.4 Safe handling of print cartridges.....	16
IV Preparation and commissioning	17
4.1 Commissioning.....	17
4.1.1 Inserting rechargeable batteries	18
4.1.2 Charge rechargeable batteries	18
4.2 Setting time and date.....	19
4.3 Setting summertime.....	19
4.4 Inserting the print cartridge.....	20
4.5 Saved print images.....	21
4.6 Activating Bluetooth.....	22
4.7 Selecting print image.....	22
4.8 Overview of stored print images.....	22
4.9 Printing the print image.....	23
4.10 Installing the REINER PCset software.....	24
4.10.1 System requirements	24
4.10.2 Installing the software	24
4.10.3 Firmware update	24
V Software application 990 REINER PCset	26
5.1 Preparing jetStamp 990 for REINER PCset.....	26
5.2 Starting the REINER PCset software.....	26

5.3	Operating interface	27
5.3.1	Menu bar	27
5.3.1.1	File	28
5.3.1.2	Edit	28
5.3.1.3	View	28
5.3.1.4	Presettings	28
5.3.1.5	Help	29
5.3.2	Toolbar	29
5.3.3	Objects	30
5.4	Establishing Bluetooth connection	31
5.5	Example workflow: Generating the print image	32
5.5.1	Configuring the print image	32
5.5.2	Transferring the print images	32
5.5.3	Printing the print image	33
5.6	Objects settings	34
5.6.1	Text	34
5.6.1.1	Presettings	34
5.6.1.2	Context menu text object	35
5.6.2	Date/Time	36
5.6.2.1	Presettings	36
5.6.2.1.1	Tab File - Settings Date / Clock time	37
5.6.2.2	Context menu date/time object	38
5.6.3	Numbering machine	39
5.6.3.1	Presettings	39
5.6.3.1.1	Tab File - Settings Date/time/numbering machine	40
5.6.3.2	Context menu numbering machine object	42
VI	Maintenance	43
6.1	Changing the print cartridge	44
6.2	Cleaning the contacts of the print cartridge	45
6.3	Clean nozzles	46
6.3.1	Manual nozzle cleaning	46
6.4	Clean print carriage	46
6.5	Clean housing	47
VII	Recognising and removing interferences	48
7.1	Operating modes and error messages	48
VIII	Technical data and accessories	49
8.1	Type plate	49
8.2	Technical data	50
8.3	Transport and disposal	51
8.4	Accessories	51
IX	Contact	52
X	Operating instructions	53

Index**54**

1 Your jetStamp

REINER*jetStamp 990*

1.1 Operating elements

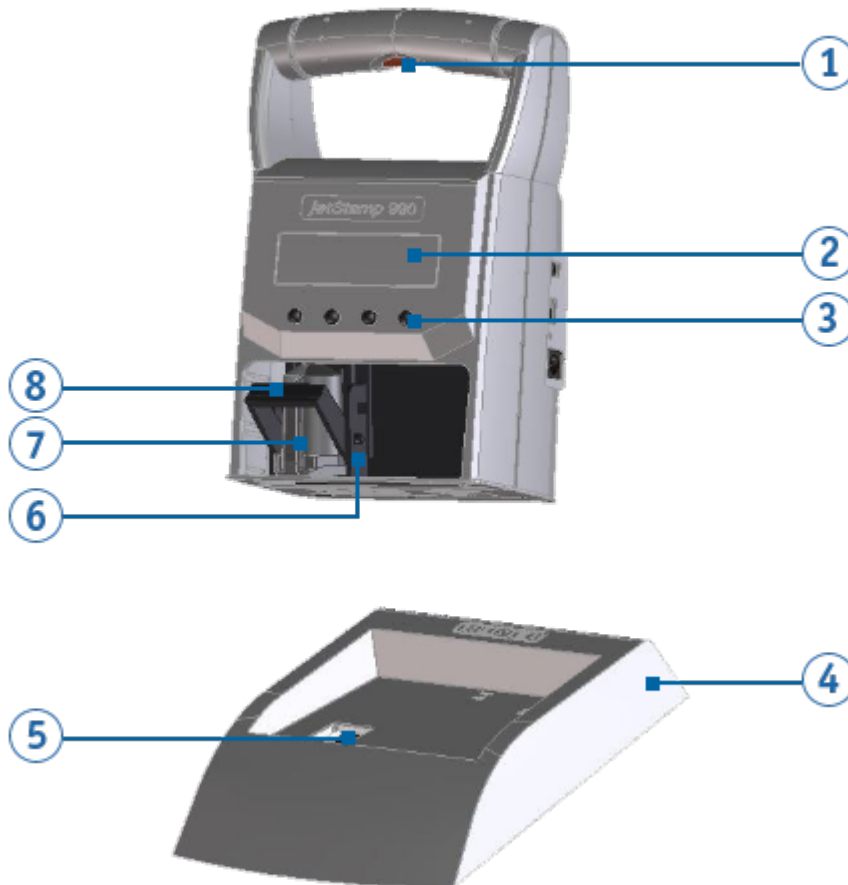
A

B

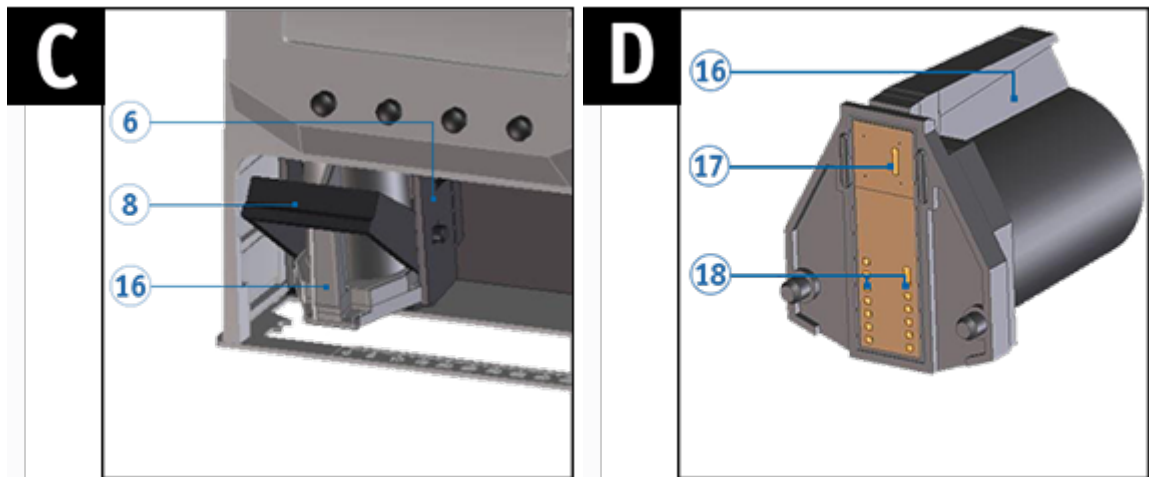

- ① Trigger button
- ② Display
- ③ Key pad
- ④ Basis station
- ⑤ Ink cleaning station
- ⑥ Print carriage
- ⑦ Print cartridge
- ⑧ Locking bracket
- ⑨ Battery compartment

- ⑩ Flap for battery compartment
- ⑪ Reset button
- ⑫ Connection socket for mains adapter
- ⑬ Charging indicator
- ⑭ Micro USB socket
- ⑮ Jack socket for external triggering
- ⑯ Grip strip print cartridge
- ⑰ Nozzles print cartridge
- ⑱ Print cartridge contacts



1.2 Display and button function

The display depends on the respective menu context. The start screen of the main menu is shown.

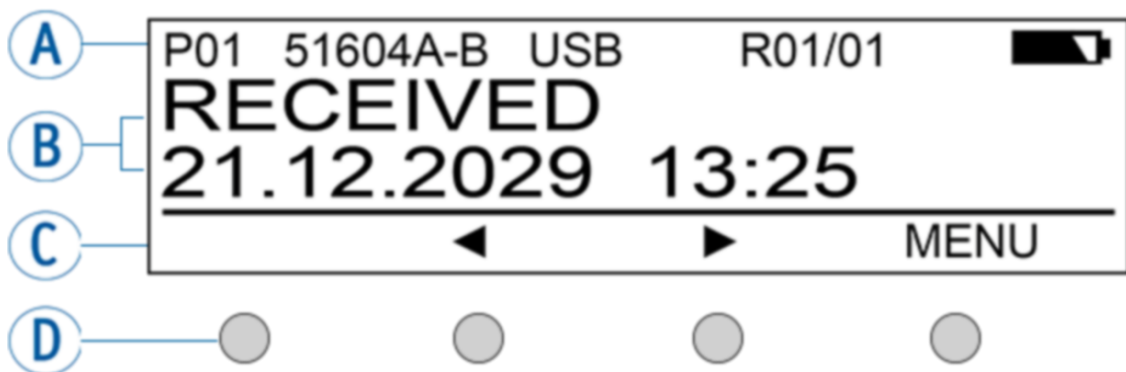
The display is structured according to the following sections:



A Header

P01	Number of the set print image
51604A-B	Cartridge type used
USB	USB active
BT/BTC	Bluetooth active/Bluetooth connected
R01/01	Repeat switching of the numbering machine 1
	Battery level
	Battery is charging

B Set print image

Text, date/time or numbering machine

C Menu bar with menu items and commands**Next page**

Forward/back through print images or menu.

[MENU] Access to the main menu and
[SELECT] menu selection - Confirms entries and completes function settings.

[RETURN] **Back**
Returns to the previous display (submenu / main menu / exit from main menu).

[OK] Confirms entries and completes function settings.

D Four push-buttons

Each button is always assigned to the menu item or command displayed in the display menu bar above it.



1.3 Main menu

 The menu selection of the device consists of main and submenus.
There are **7 main menus**:

[Cartridge change](#)
[Device Lock](#)
[Bluetooth](#)
[Date/Time](#)
[Numbering machine](#)
[Settings](#)
[Model/Version](#)

 For the button functions, see "[Display and Button Functions](#)"

1.3.1 Cartridge change

- ▶ Select the button [MENU]. Use the buttons ◀ ▶ to browse until the display shows "Cartridge change start".
- ▶ Selecting [SELECT] moves the print carriage  to the middle of the device so that the print cartridge can be inserted/changed.
- ▶ Selecting [SELECT] again moves the print carriage  back to its basic position.
- ▶ Selecting [RETURN] leaves the menu.

 Also see "[Inserting the Print Cartridge](#)" and "[Changing the Print Cartridge](#)"

1.3.2 Device lock

Print images can be protected with a password.

 When the print images are protected, the menu will show "Device Unlock". This means that a password must be entered.

- ▶ Select the button [MENU]. Use the buttons ◀ ▶ to browse until the display shows "Device Lock".
- ▶ Selecting [SELECT] enables or disables the device lock.

The symbol in the status indicator  in the REINER PCset switches from  to .

- ▶ Selecting [RETURN] leaves the menu.

 Also see "[Settings - Password change](#)".

1.3.3 Bluetooth

 Only the 990-001 model is bluetooth-capable.

 Bluetooth cannot be activated while an USB connection is active.

 If Bluetooth is active the battery runtime reduces since Bluetooth is active in standby mode as well.

- ▶ Select the button [MENU]. Use the buttons ◀ ▶ to browse until the display shows "Bluetooth".
- ▶ Selecting [SELECT] enables or disables Bluetooth.
- ▶ Selecting [RETURN] leaves the menu.

1.3.4 Date/time

Change clock

- ▶ Select the button [MENU]. Use the buttons ◀ ▶ to browse until the display shows "Date/Time".

Setting the date and time at the *jetStamp 990*.

- ▶ Select the button [SELECT]; the display shows "Change clock".
- ▶ Push the button [SELECT] again and use the buttons ◀ ▶ and [OK] to set the date/time.
- ▶ Select the button [OK] to accept the changes
- ▶ Selecting [RETURN] leaves the menu.

 See "Preparation and commissioning" under "[Setting Date/Time](#)".

Summertime

- ▶ Selection between Europe/America/None

 See "Preparation and commissioning" under "[Setting summertime](#)".

1.3.5 Numbering machine

Numb. machine 1 - 4 (numbering machine 1 - 4)

The numbering machine serves sequential numbering.

Up to 4 different numbering machines can be specified.

A numbering machine used in the selected print image is marked with an appended "*" here. The specified "Numb. machine 1", for example, is displayed as "Numb. machine 1*".

 See "Software application 990 PCset", "[Settings Objects - Numbering Machine](#)".

1.3.6 Settings

Cartridge type

Select the button [MENU]. Use the buttons ◀ ▶ to browse until the display shows "Settings" and then "Cartridge type".

- ▶ Select [SELECT] to choose the print cartridge.

Possible selections are:

51604A-B (P1-S-BK)

51605R-R (P1-S-RD)

P1-EF-AUB

P1-EF-RD

P1-MP2-BK

P1-MP3-BK

P1-MP4-BK

P1-MP6-YE

P1_AMI_EM

 Also see "Technical data and accessories" under "[Accessories](#)".

Double print

Select the button [MENU]. Use the buttons ◀ ▶ to browse until the display shows "Settings" and then "Double print".

- ▶ Select [SELECT] to enable or disable the double print.

Password menu

Select the button [MENU]. Use the buttons ◀ ▶ to browse until the display shows "Settings" and then "Password menu ON/OFF".

Selecting [SELECT] to choose between "ON" and "OFF".

- ▶ "ON" means that the menu access is password-protected. You can only return to the menu after entering the password.
The print images can, however, be selected and printed out on the device.

Password change

Select the button [MENU]. Use the buttons ◀ ▶ to browse until the display shows "Settings" and then "Password change".

- ▶ After selecting [SELECT], you will be asked to assign a new password.
- ▶ Confirm your selection with [OK] or undo it with [RETURN].

Factory settings

- ▶ Select [SELECT] to reset the *jetStamp* 990 to the delivery condition.

 The print images at delivery are, however, not restored. A password set also cannot be reset this way.

1.3.7 Model version

Model

- ▶ Select [OK] to display the model and serial number.

Software version

- ▶ Selecting [OK] to display the firmware status.

 See "Software application 990 REINER PCset" under "Operating interface" "[Menu bar help](#)".

2 Important notes

Before commissioning of the *jetStamp* 990 always read the operating instructions and in particular the safety notes with care. This prevents insecurities in handling of the marking devices and connected safety risks to keep you safe and avoid damage to the device.

[Rechargeable batteries](#)

2.1 Rechargeable batteries

The charging of the batteries is electronically controlled. This ensures that the battery cells are charged optimally and gently.



Recharging

► Fully charge rechargeable batteries before first application. Duration approx. three hours.

After the first full charge, the batteries do not yet reach full capacity. You must expect that the normal service times will be undercut.

Reaching full capacity

Full capacity is achieved when the batteries are completely discharged and charged several times.

 Charging is possible via the enclosed plug-on mains adapter or the connection socket  ¹², as well as via a micro USB socket  ¹⁴.

3 Your safety

[Safety description](#)

[Safety notes on rechargeable batteries](#)

[Safety notes](#)

[Safe handling of print cartridges](#)

3.1 Safety, description

DANGER

Warnings of dangers that lead to **death or severe injury directly** if not observed.

WARNING

Warnings of dangers that may lead to **death or severe injury** if not observed.

CAUTION

Warnings of dangers that may lead to **injury** if not observed.

NOTICE

Warnings of dangers that may lead to **property damage** if not observed.



Observe the operating instructions.

▶ You are asked to perform actions here.



Notes and advice to make handling your *jetStamp 990* even easier.



Notes on instruction videos.

3.2 Safety notes on rechargeable batteries

Rechargeable batteries are subject to wear. A longer service life than six months cannot be warranted.

WARNING

Possible explosion in contact with fire.

- ▶ Do not forcefully open rechargeable batteries.
- ▶ Do not expose rechargeable batteries to severe heat
- ▶ Do not expose rechargeable batteries to extremely low barometric pressures.

CAUTION

Injuries resulting from destruction of the battery when using unsuitable rechargeable batteries or non-rechargeable batteries.

- ▶ Only use the batteries intended for the device.

Type usage

Use only the enclosed mains adapter to charge the rechargeable batteries.

Only use rechargeable batteries (two each) type nickel metal hydride (NiMH, REINER item number: 946 192 - 000) of build AA.

Always replace all flat rechargeable batteries at once.
Unauthorised batteries may cause damage or malfunction.

- ▶ Use only prescribed rechargeable batteries.

Insertion

Observe polarity of rechargeable batteries when inserting (refer to the battery symbols in the battery compartment)!

3.3 Safety notes

⚠ CAUTION

Possible tripping and damage to the device due to device lines lying freely in the room.

- ▶ Place the device lines so that they do not pose any danger source!

NOTICE

Damage to the device at improper transport.

- ▶ Only use packaging that provides protection from impact and shock for the device!

NOTICE

Damage to the device by dewing.

- ▶ Before commissioning, wait until the device has reached room temperature and is completely dry!

 Only trained specialists should perform repairs.

3.4 Safe handling of print cartridges

⚠ WARNING

Possible blindness due to eye contact with ink.

- ▶ Do not point the *jetStamp* 990 nozzles against people's faces!

⚠ CAUTION

Damage to health caused by ingestion of ink.

- ▶ Do not swallow!
- ▶ Keep the print cartridge out of the reach of children!

4 Preparation and commissioning

[Commissioning *jetStamp* 990/990 BT](#)

[Setting Date/Clock Time](#)

[Inserting the print cartridge](#)

[Saved print images](#)

[Selecting print image](#)

[Overview of stored print images](#)

[Printing the print image](#)

[Installing the REINER PCset](#)

4.1 Commissioning

 Only connect the device to the PC after the REINER PCset software has been installed (see "[Installing the REINER PCset](#)").
With the installation of the REINER PCset software, the required USB drivers are installed. If a connection is established between the PC and the device, the USB drivers are automatically detected and loaded. If the device is connected without installing the REINER PCset software, the installation of the device drivers fails.

 The batteries must be fully charged before first application.

 The menu selection on the device is in English only.

[Inserting rechargeable batteries](#)

[Charge rechargeable batteries](#)

4.1.1 Inserting rechargeable batteries

i The batteries must be fully charged before first application. The charging time is approx. three hours. The batteries are charged when the green charging indicator is off **13**.

Inserting rechargeable batteries ⇨ Fig. **B**

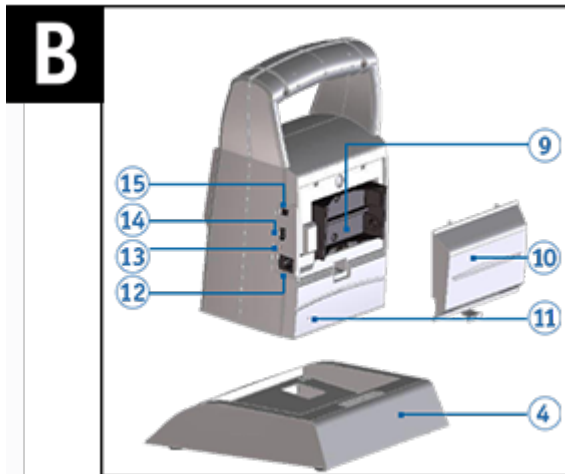

Always replace all flat rechargeable batteries at once.
When the batteries are removed, the date, time and counter reading of the numbering machines are maintained.

- ▶ Open the battery compartment flap **10** at the rear of the marking device.
- ▶ Ensure correct polarity and insert the batteries.
- ▶ Close the battery compartment flap **10**.

4.1.2 Charge rechargeable batteries

- ▶ Connect the mains adapter of the device to the connection socket provided for the mains adapter **12** and connect it to the mains, or connect the device to a running PC by micro USB **14**.
Green charging indicator **13** lights up.
Charging is complete when the charging indicator **13** is off.

4.2 Setting time and date

- ▶ Push [MENU] and browse ◀ ▶ until the display shows "Date/Time".
- ▶ Push [SELECT].
"Change clock" appears.
- ▶ Push [SELECT].

Display: **yyyy mm dd hh mm**

- ▶ The year "**yyyy**" flashes; push ◀ ▶ in order to set the year.
- ▶ Push [OK].
- ▶ The month "**mm**" flashes; push ◀ ▶ in order to set the month.
- ▶ Push [OK].
- ▶ The day "**dd**" flashes; push ◀ ▶ in order to set the day.
- ▶ Push [OK].
- ▶ The hours "**hh**" flash; push ◀ ▶ to set the hours.
- ▶ Push [OK].
- ▶ The minutes "**mm**" flash; push ◀ ▶ in order to set the minutes.
- ▶ Push [OK].
"Change clock" appears again.
- ▶ Push [RETURN].
[Date/Time] appears.
- ▶ In order to get right to the next menu item, push ◀ ▶.
– OR –
- ▶ In order to save the settings and leave the menu,
Push [RETURN] twice.
The selected print image appears.

4.3 Setting summertime

- ▶ Push [MENU] and browse ◀ ▶ until the display shows "Date/Time".
- ▶ Push [SELECT] and browse ◀ ▶ until the display shows "Summertime".
- ▶ Push [SELECT].
- ▶ The display "Europe" is flashing. Push ◀ ▶ to get to the display "America" or "None" and make your selection.
- ▶ Push [OK] to save.
"Summertime" appears.
- ▶ Push [RETURN].
"Date/Time" appears.
- ▶ In order to get right to the next menu item, push ◀ ▶.
– OR –
- ▶ In order to save the settings and leave the menu,
Push [RETURN] twice.
The selected print image appears.

4.4 Inserting the print cartridge

i When using special ink (MP), observe the notes in the operating instructions on the print cartridge.

⚠ CAUTION

Damage to health caused by ingestion of ink.

- ▶ Do not swallow!
- ▶ Keep the print cartridge out of the reach of children!

Inserting the print cartridge ⇒ Fig. **A** + **C** + **E**

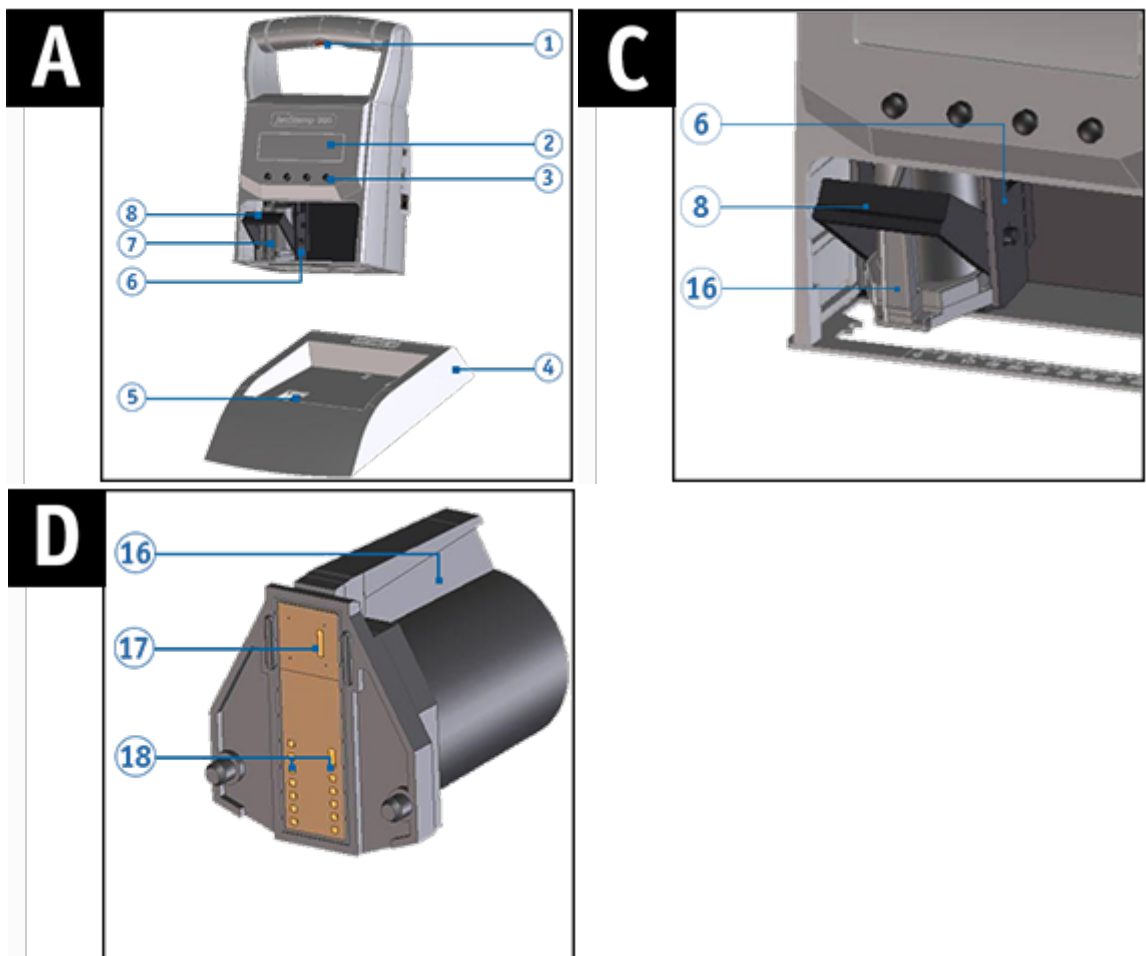

- ▶ Take the *jetStamp* 990 from the basis station **4**.
- ▶ Push [MENU].
"Cartridge change Start" appears on the display.
- ▶ Push [SELECT].
Print carriage moves to the device centre.
"Cartridge change end" appears on the display.
- ▶ Push the locking bracket **8** into the rear-most position.
- ▶ Unpack the new print cartridge **7** and remove the protective film or clip.
(see operating instructions for the print cartridge P1).

- ▶ Insert the print cartridge into the print carriage 7 at the grip strip 16.
- ▶ Pull the locking bracket 8 forward again.
- ▶ Push [SELECT].
The print carriage moves to its basic position.
- ▶ In order to get right to the next menu item, push ◀ ▶.
- OR -
- ▶ To leave the main menu, push [RETURN].
The selected print image appears.







4.5 Saved print images

Up to 25 print images (P01 to P25) can be stored in the device.

P01 to P05 are print images pre-set in the factory (see "[Overview of stored print images](#)"). They contain individually print fields such as "Text", "Numbering machine", "Date/time". They can also be set anew or changed.

The active print image is displayed at the upper left of the display, e.g. P09.

4.6 Activating Bluetooth

-  Only the 990-001 model is bluetooth-capable.
-  Bluetooth cannot be activated while an USB connection is active.
-  If Bluetooth is active the battery runtime reduces since Bluetooth is active in standby mode as well.
-  Select the button [MENU]. Use the buttons ◀ ▶ to browse until the display shows "Bluetooth".
-  Selecting [SELECT] activates Bluetooth.
-  To establish the Bluetooth connection with the device, follow the instructions "[Establishing Bluetooth connection](#)". [Bluetooth-Verbindung-herstell2](#)".

4.7 Selecting print image

In order to make settings at the print images, they need to be selected or activated first.

-  Browse ◀ ▶ until the desired print image appears on the *jetStamp* 990.

4.8 Overview of stored print images

Print image P01 = text + current date + time

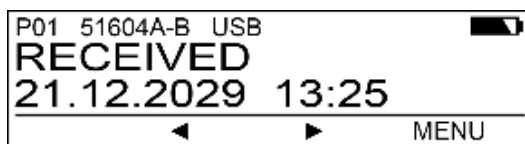

Print image P02 = text + current date and text + pre-dated date)

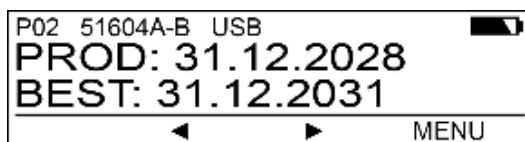

Print image P03 = text + current date and text + numbering machine

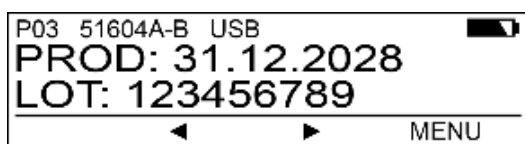

Print image P04 = date

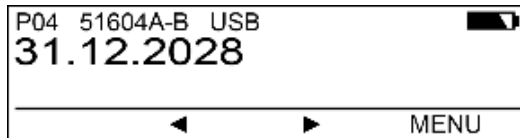

Print image P05 = numbering machine

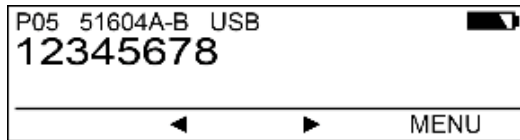

4.9 Printing the print image

⚠ WARNING

Possible blindness due to eye contact with ink.

- ▶ Do not point the *jetStamp* 990 nozzles **17** against people's faces!

Printing the print image ⇒ Fig. **A** + **D**

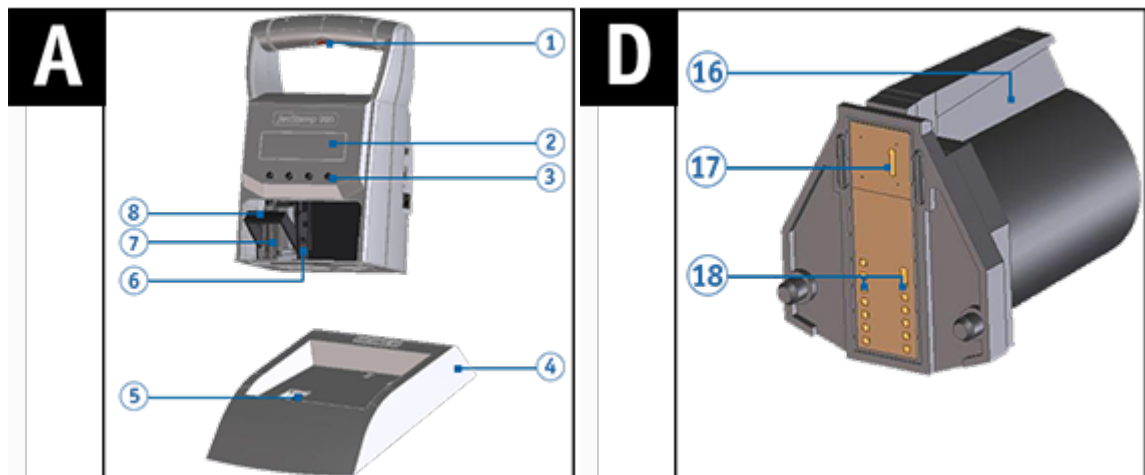

- ▶ Setting the desired print image (see "[Selecting the print image](#)").
- ▶ Place the device on a surface to be printed.
- ▶ Push the trigger button **1**.
The selected print image is printed.

4.10 Installing the REINER PCset software

 The installation must be carried out on a commercially available local PC. A virtualised PC or thin client is not suitable.

[System requirements](#)

[Installing the software](#)

4.10.1 System requirements

Supported REINER devices

- *jetStamp* 990

Hardware

- PC with Pentium CPU (or compatible) or higher
- Graphics adapter with a min. resolution of 800 x 600 pixels (at least 256 colours; optimal: TrueColor, 24 bit, 16,78 million colours)
- Memory 32 MB min.
- 10 MB free hard disk space
- 1 free USB interface

Supported operating systems

- Windows 7, Windows 7 64 Bit, Windows 8, Windows 8 64 Bit, Windows 10, Windows 10 64 Bit

4.10.2 Installing the software

Administrator rights on the PC are required for the installation.

- ▶ Insert installation medium (USB stick or CD) in the PC.
- ▶ If the installation program does not start automatically, start the file "**Setup_PCset.exe**".
- ▶ Follow the instructions of the installation program.

 You can also download the software in the *jetStamp* 990 product area of our website under [Downloads - Software PCset](#).

4.10.3 Firmware update

The latest firmware for the *jetStamp* 990 can be downloaded from the REINER website, www.reiner.de, in the [downloads](#) section.

 Uploading print images that were not saved on the PC (see "[File](#)").

Ensure that the REINER PCset is installed on your PC but **not** opened before the firmware update is started. While the firmware update is being installed, the *jetStamp* 990 must not be switched off or removed from the supply voltage.

- ▶ Connect the mains socket **15** to the supply voltage via the mains adapter.
- ▶ Connect the micro USB socket **17** to the PC via the USB cable.
- ▶ **Unpack "Firmware update"** and start "**jetStamp990_Firmware_xxxx.exe**". The firmware is installed automatically. After a successful firmware update, the REINER PCset can be opened again.

5 Software application 990 REINER PCset

[Preparing jetStamp 990 for REINER PCset](#)

[Starting the REINER PCset software](#)

[Operating interface](#)

[Establishing Bluetooth connection](#)

[Example workflow: Generating the print image](#)

[Objects settings](#)

5.1 Preparing jetStamp 990 for REINER PCset

Preparing the *jetStamp* 990 for REINER PCset ⇨ Fig. **B**

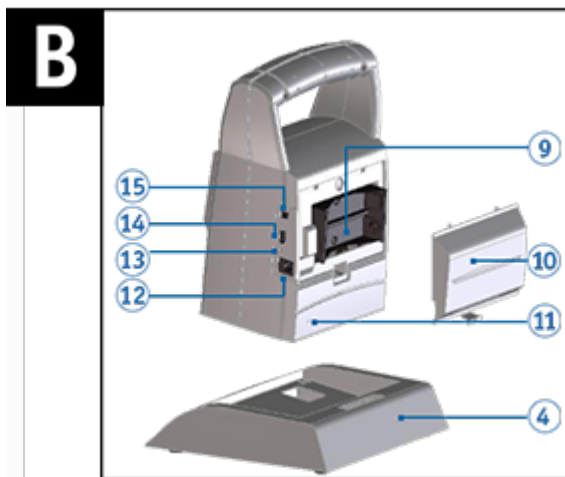

i The PC can only recognise the device correctly if the REINER PCset is installed first. Find more on this under: [Installing the software](#).

- ▶ Double-click the **REINER PCset icon**  .
The REINER PCset software is started.
- ▶ Connect the Micro USB socket **14** to the PC via the USB Bluetooth cable.
The PC recognises the *jetStamp* 990 as a new USB device.
The device driver software is installed automatically.

5.2 Starting the REINER PCset software

- ▶ Double-click the **REINER PCset icon**  .
The REINER PCset software is started.

5.3 Operating interface

The operating interface is divided into four sections:

- a) Menu bar
- b) Toolbar
- c) Register 1 - 25 (print image P01 - P25)
- d) 2 lines for design of the print images
- e) Status indicators

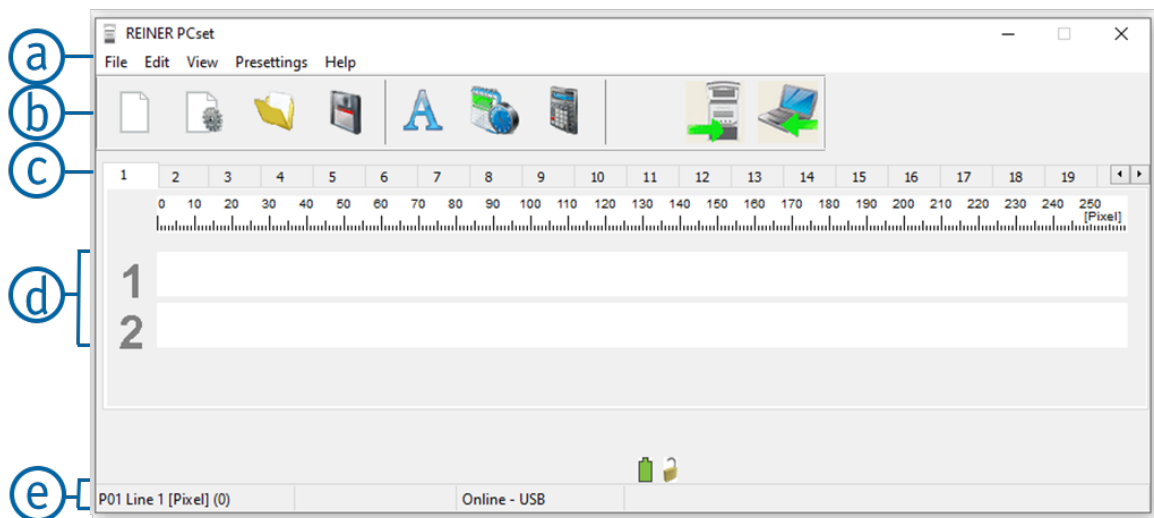

5.3.1 Menu bar

In addition to the functions in the tool bar **b**, you can find a menu bar in the REINER PCset application **a**.

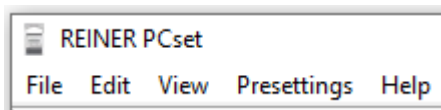

In the menu bar you will find both common, self-explanatory standard commands as well as REINER PCset -specific menu commands.

[File](#)

[Edit](#)

[View](#)

[Presettings](#)

[Help](#)

5.3.1.1 File

Function	Description
New	Reset the display. Delete the displayed draft.
Open	File selection menu for loading previously saved print images.
Save	Save the displayed print image as RPSG file.
Save as	The dialogue for saving the print images appears.
Device settings date/time/numbering machine	Configure the date/time and numbering machine.
Device settings	Configure the print settings, signals, and functions.
Transferring the print images	Print images are transferred to the device.
Upload print images	The print images are uploaded onto the PC.
Find REINER Bluetooth devices	Searches for REINER Bluetooth devices.
Last opened	Displays the most recently opened print images.
Exit	Ends the REINER PCset.

5.3.1.2 Edit

Function	Description
Delete	Deletes selected objects.
Copy	Load selected content to the clipboard.
Insert	Paste content from the clipboard.
Cut	Delete selected contents.

5.3.1.3 View

Function	Description
Language	Setting language: German, English, French, Spanish, English (Cyrillic CP 855), English (Greek CP 869)
Unit	Pixel, mm, inch

5.3.1.4 Presettings

 Settings are PC-specific.

The settings (properties of text, date/time, and numbering machine objects) are generally valid. These settings are accessible for all users.







Function	Description
Text	Settings for text objects can be configured.
Date/Time	Settings for date/time objects can be configured.
Numbering machine	Settings for numbering machine objects can be configured.

5.3.1.5 Help

Function	Description
Help	Calling up the online help.
Info	Information on REINER PCset and connected <i>jetStamp</i> 990.

5.3.2 Toolbar





Objects can be pulled into the line by drag & drop.
An imprint may have up to two lines and up to 20 characters per line.

Toolbar 	Command	Description
	New	Reset the display. Delete the displayed draft.
	Device settings date/time/numbering machine	Configure the date/time and numbering machine.
	Open	File selection menu for loading previously saved print images.
	Save	Save the displayed print image as RPSG file.
	Transfer	Print images are transferred to the device.
	Upload	The print images are uploaded onto the PC.

5.3.3 Objects

Print images are composed of objects from the object groups described below. Objects can be placed freely using drag & drop (see "[Example Workflow: Generate Print Image](#)").

 Double-click or right-click the symbols in the tool bar  to call further settings.



Toolbar 	Command	Description
	Text	The text in the text input field is inserted into the lines of the print image by drag & drop of the text object.
	Date/Time	A date/time object can be placed either in the first or the second line. One date/time object per line is permitted. The calendar data of the different date objects can be set deviating from each other.
	Numbering machine	A numbering machine object can be placed either in the first or the second line. The numbering machine is used for sequential numbering.

5.4 Establishing Bluetooth connection

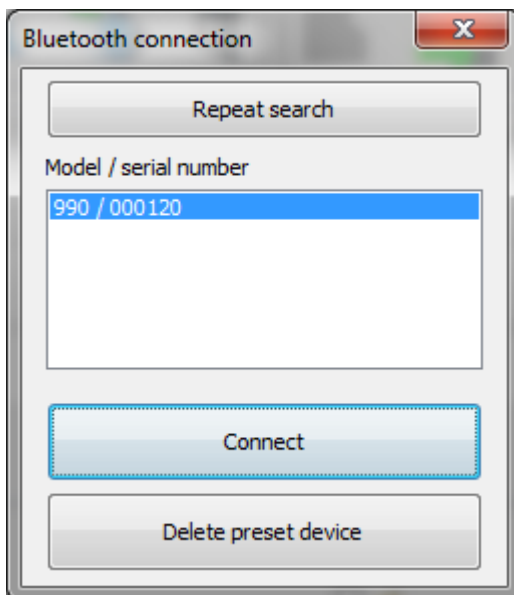

- ▶ To establish a Bluetooth connection, Bluetooth must be activated on the device (see "[Activate Bluetooth](#)").
- ▶ Opening the REINER PCset.
- ▶ In the menu bar  select the "File" tab and click "Search for REINER Bluetooth devices".
An automatic search is started.
All devices found, as well as all devices that have already been connected to the REINER PCset, are displayed with model and serial number.

-  If the *jetStamp* 990 is not found, a new search run can be started with the "Search again" button.
Note that Bluetooth must be activated on the device for this!
The status line in the device must show "BT" for this.



- ▶ To establish the Bluetooth connection, select the corresponding device in the list and click "Connect".
A pop-up menu "Connection via Bluetooth device" opens in the Windows status bar.
- ▶ After a short time the *jetStamp* 990 is connected to the REINER PCset.
-  The connected device is saved as a permanent connection so that the REINER PCset always connects to this device as soon as it is available.
-  When REINER PCset is connected to the *jetStamp* 990, the device display shows BTC.
- ▶ To cancel the permanent connection, click the "Delete pre-set device" button in the Bluetooth dialogue or establish a connection with another device.

5.5 Example workflow: Generating the print image

- ▶ Click the **Upload symbol**  in order to upload the print images of the **jetStamp 990** on the PC.
- ▶ Change the desired print image (see [Configuring the print image](#)).
- ▶ Click the **transfer symbol**  to transfer the print images to the device (see [Printing the print image](#)).







[Configuring the print image](#)

[Transferring the print image to jetStamp 990](#)

[Printing the print image](#)

5.5.1 Configuring the print image

Inserting text, date/time, or numbering machine

- ▶ To create a text object, left-click on the **text symbol**  in the tool bar,  drag it to the desired line and position and drop it there.
- ▶ Write the desired text into the text field and accept with OK.
- OR -
- ▶ In order to create a date/time object, left-click the **date/time symbol**  in the tool bar,  drag it to the desired line and position and drop it there.
- OR -
- ▶ To create a numbering machine object, left-click on the **numbering machine symbol**  in the tool bar,  drag it to the desired line and position and drop it there.

 For further commands, see "[Toolbar](#)".

5.5.2 Transferring the print images

All present print images are transferred in every case. A single print image cannot be transferred.

- ▶ Click on the **transfer icon** .
After successful transfer, the following message appears after a few seconds:

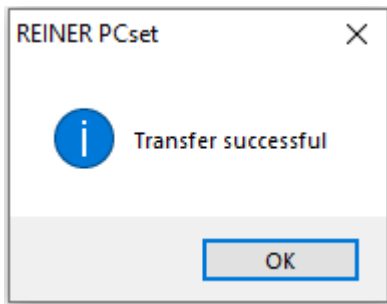

The print images are saved in the *jetStamp* 990 and can now be printed.

5.5.3 Printing the print image

⚠ WARNING

Possible blindness due to eye contact with ink.



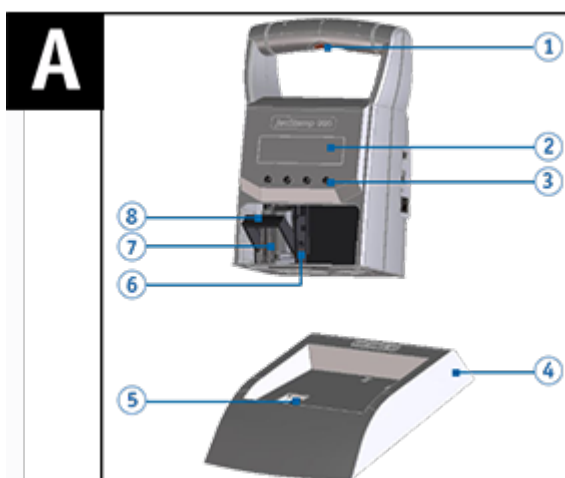

- ▶ Do not point the *jetStamp* 990 nozzles **17** against people's faces!



Print the print image ⇒ Fig. **A**



- ▶ Browse ◀ ▶ until the desired print image appears on the *Jetstamp* 990.
- ▶ Place the device on the surface to be printed.
- ▶ Push the trigger button **1**.
The selected print image is printed.

5.6 Objects settings

 Pull the symbols for text , date/time,  and numbering machine  into the line simply and quickly by drag & drop.

 Right-clicking the symbols (see "[Objects](#)") in the tool bar  calls up further settings. The settings of a single object can also be changed subsequently by right-clicking on it and then choosing Edit.

The settings of the objects can also be selected in the menu bar  by clicking the "Presettings" tab or via the context menu.

[Text](#)

[Date/Time](#)

[Numbering machine](#)

5.6.1 Text



Creates text fields.

When a text object is inserted, the configuration corresponds to the presettings".

Each one can be changed individually via the "context menu text object".

- ▶ Click the symbol for the **text** , hold the mouse button down, drag it to the desired line/position and release the mouse button.
- ▶ The configuration window for "Text" opens (see [Presettings](#)).

[Presettings](#)

[Context menu text object](#)

5.6.1.1 Presettings

Changed presettings apply to all future text objects.

- ▶ In the menu bar  select the "Presettings" tab and click "Text".
The configuration window for "Text" opens as shown in the following figure:

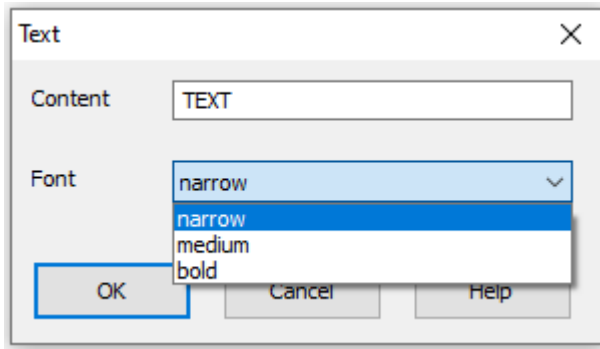

Function	Description
Contents	Enter the desired text.
Font	Selection option: narrow, medium, bold.

5.6.1.2 Context menu text object

- ▶ To open the context menu, right-click the desired text object.
The context menu opens as in the following figure:

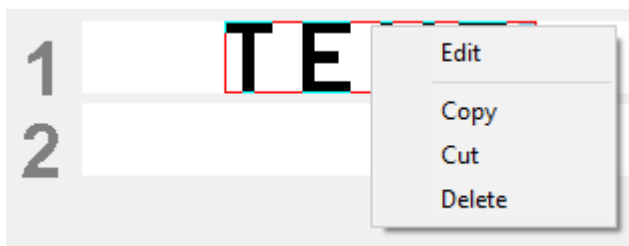

Function	Description
Edit	Object becomes active and can be edited.
Copy	Copies the object.
Cut	Cuts out the object.
Insert	If there is a text in the clipboard, it will be pasted.
Delete	Deletes the object.

i Enter or double-click fixes the object, which then can no longer be edited.

5.6.2 Date/Time



Creates the format of date and time.

When a date/time object is inserted, the configuration corresponds to the presettings". Each date/time object can be changed individually via the context menu.

- ▶ Click the symbol for the **date/time** , hold the mouse button down, drag it to the desired line/position and release the mouse button.
- ▶ The configuration window for "Date/time" opens (see [Presettings](#)).

[Presettings](#)

[Context menu date/time object](#)

5.6.2.1 Presettings

Changed presettings apply to all future date/time objects.

- ▶ In the menu bar  select the "Presettings" tab and click "Date/time". The configuration window for "Date/time" opens as shown in the following figure:

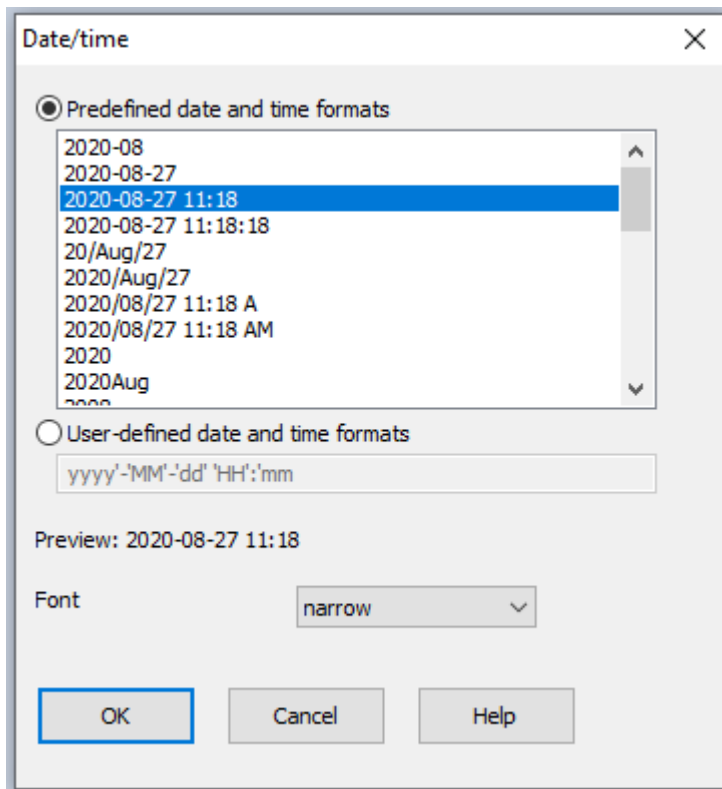

Function	Description
----------	-------------

Predefined date and time formats	List of preconfigured formats. Selection by clicking.
User-defined date and time formats	Shows the selected format in the draft view. The format can be manually configured. One abbreviation of a category each from the following table "Format abbreviation" can be used once. Additional characters (also spaces) are inserted by being included in simple apostrophes ('). For verification, the text is written in "red" once the entered format is no longer OK.
Preview	Preview of the selected format with the current system date.
Font	Selection option: narrow, medium, bold.

Format abbreviation

Function	Description
dd	Day of the month with two digits (01 to 31)
ddd	Calendar day with three digits (001 to 365) Example: 28 May 2019 = 148.2019
MM	Month of the year with two digits (01 to 12)
MMM	Abbreviation for the month (up to 3 characters)
yy	The last two digits of the year (00 to 99)
yyyy	Complete year (0000 to 9999)
HH	Hour with two digits (00 to 23)
hh	Hour with two digits (01 to 12)
mm	Minutes with two digits (00 to 59)
ss	Seconds with two digits (00 to 59)
t	One character for twelve-hour format with the letters A or P
tt	Two characters for twelve-hour format with the letters AM or PM

[Tab File - Settings Date / Clock time](#)

5.6.2.1.1 Tab File - Settings Date / Clock time

- ▶ Click the tab "File" to open the dialogue "Settings Date/time/numbering machine".

A dialogue opens as in the following figure:

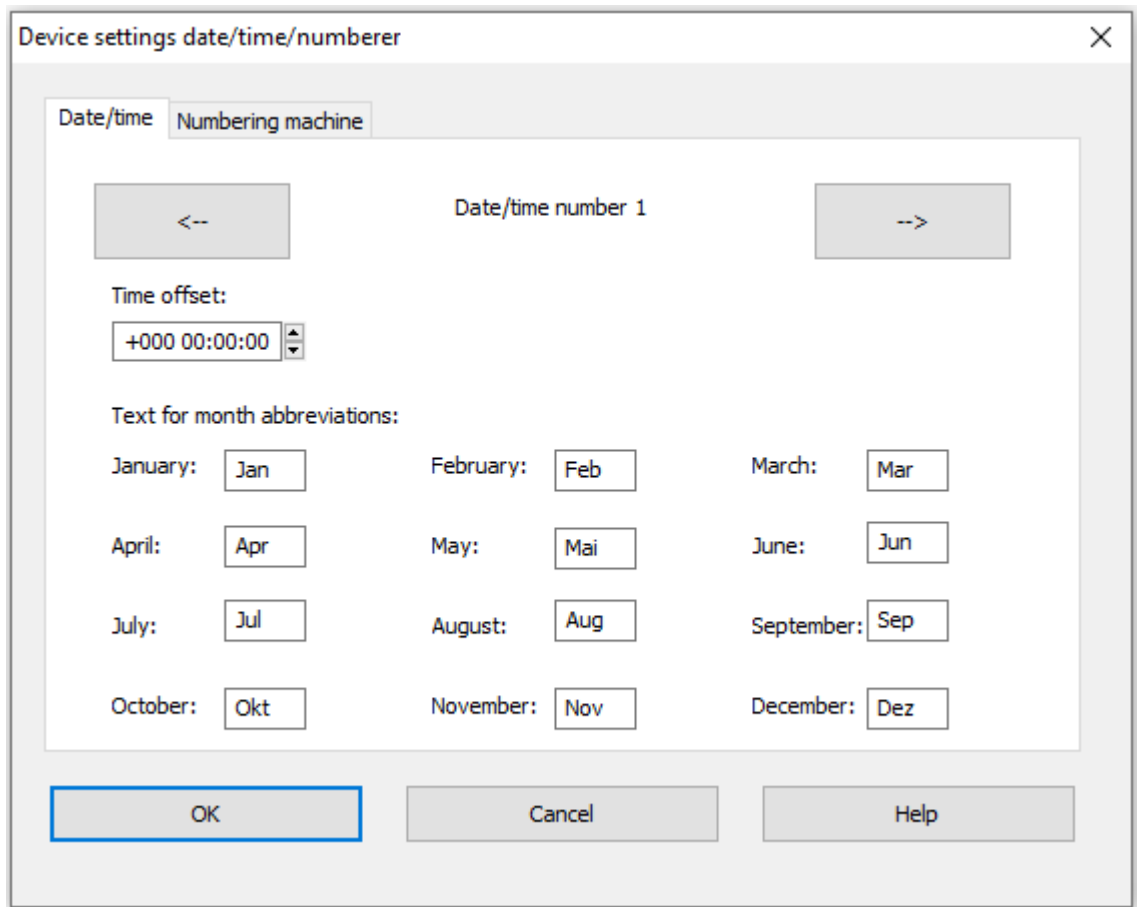

Function	Description
Time offset	The configuration of an offset for date and time can be used, for example, to automatically calculate expiration dates. Enter or select offset. The time offset has the format ttt hh:mm:ss. The set values are added to the current system date. Up to 4 offsets can be set up ("Date/time number 1" to "Date/time number 4").
Text for the month abbreviations	Abbreviation for the month abbreviations (3-digits)

5.6.2.2 Context menu date/time object

When a date/time object is inserted, the configuration corresponds to the presettings. Each date/time object can be changed individually via the context menu.

- ▶ To open the context menu, right-click the desired date/time object.
The context menu opens as in the following figure:

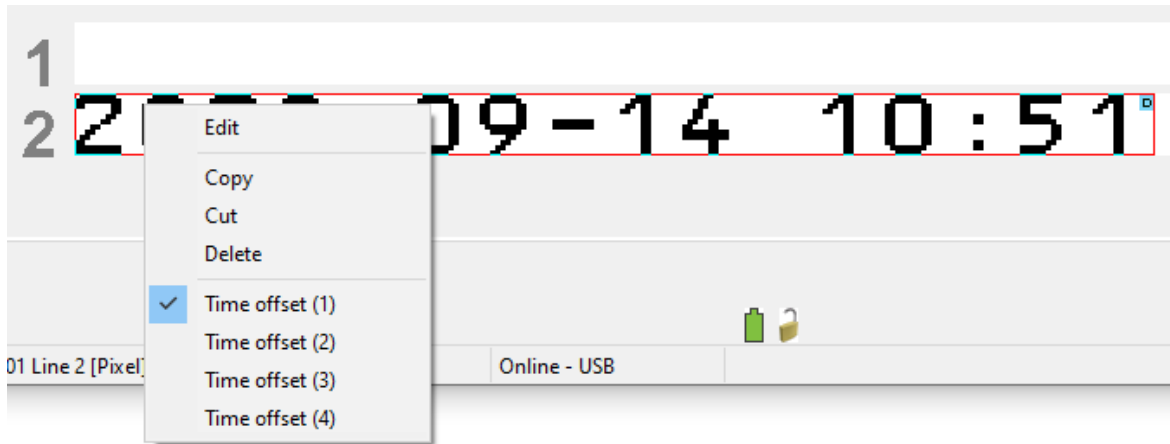

Function	Description
Edit	Opens the configuration window for date and time for the selected date/time object.
Copy	Copies the object.
Cut	Cuts out the object.
Delete	Deletes the object.
Time offset (1 to 4)	Select previously specified time offset (Tab File - Settings Date/time) .

5.6.3 Numbering machine



The numbering machine is used for sequential numbering. When a numbering machine object is inserted, the configuration corresponds to the presettings". Each one can be changed individually via the "Context menu numbering machine".

i The minimum length is 1 character; the maximum length is 8 characters.

- ▶ Click the symbol for the **numbering machine**  , hold the mouse button down, drag it to the desired line/position and release the mouse button. The configuration window for "Numbering machine" opens (see [Presettings](#)).

[Presettings](#)

[Context menu numbering machine object](#)

5.6.3.1 Presettings

Changed presettings apply to all future numbering machine objects.

- ▶ In the menu bar **a** select the "Presettings" tab and click "Numbering machine". The configuration window for "Numbering machine" opens as shown in the following figure:

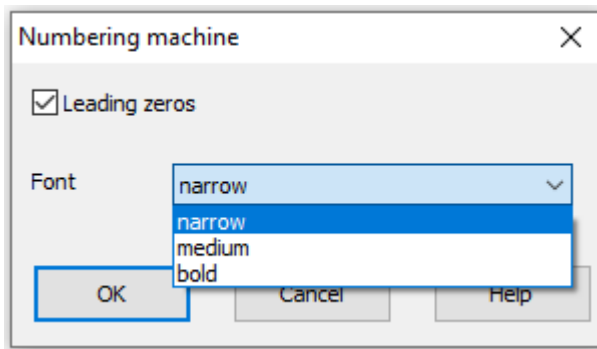

Function	Description
Leading zeroes	Leading zeroes can be suppressed or printed (e.g. 5 or 0000005). The number of printed digits depends on the maximum value set at "number circle".
Font	Selection option: narrow, medium, bold.

[Tab File - Settings Date / Clock time](#)

5.6.3.1.1 Tab File - Settings Date/time/numbering machine

- ▶ Click the tab "File" to open the dialogue "Settings Date/time/numbering machine" and then click "Numbering machine".
A dialogue opens as in the following figure:

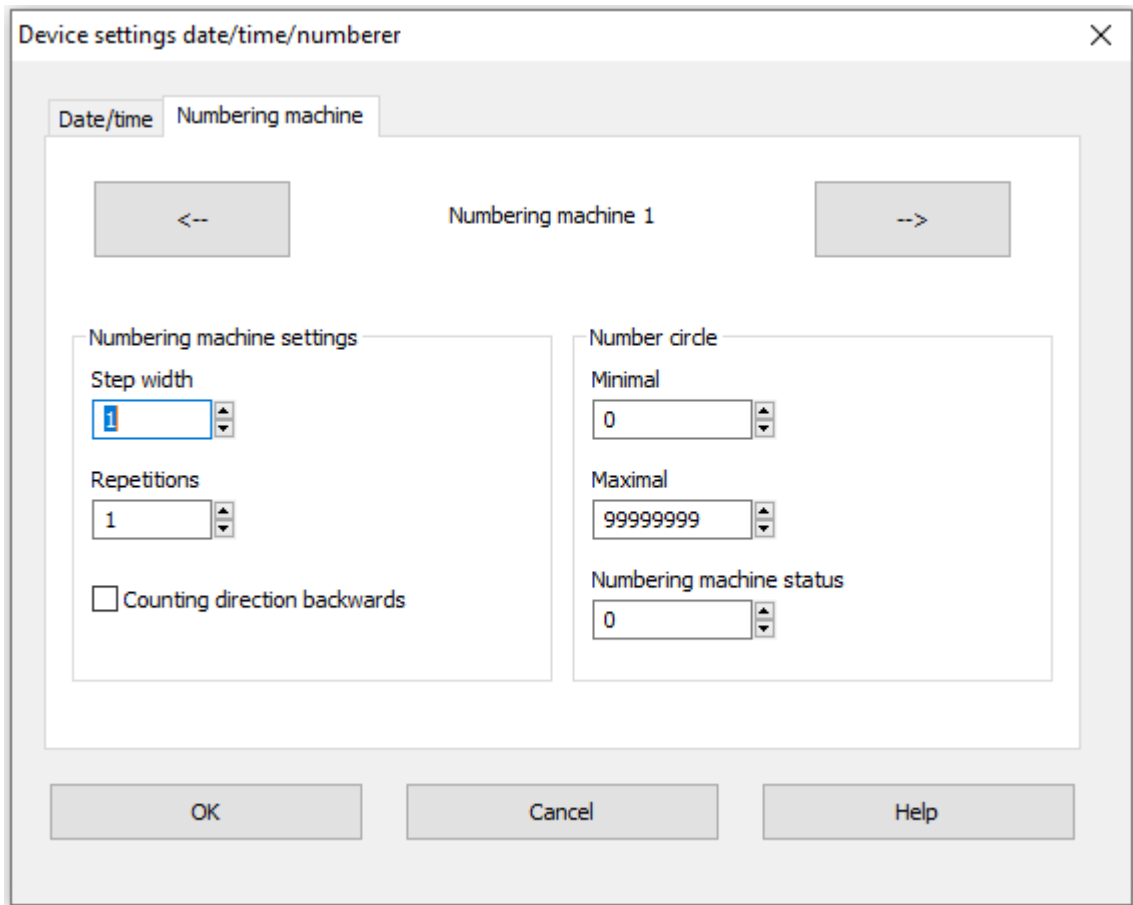

Numbering machine settings

Function	Description
Step	Indicates the interval at which the numbering machine counts on (e.g. 1,4,7... in steps of 3).
Repetitions	Indicates the number of repetitions of a print image. If, e.g., the value 3 is set, the numbering machine remains on the same number for three imprints before it counts on. The repeat factor can be set from 0 to 99. The numbering machine switches on at the value 0.
Counting direction backwards	The numbering machine can count up (e.g. 10,11,12,...) or down (e.g. 10,9,8...).

Number circle

The number circle defines the value range in which a numbering machine counts.

When the maximum or minimum value is reached (for upwards or downwards counting numbering machine), the count is continued at the respective other end of the scale.

Function	Description
Minimum	This value marks the lower limit of the number circle and thereby at the same time determines the number of digits to be printed if

	leading zeroes are activated.
Maximum	This value marks the upper limit of the number circle.
Numbering machine status	The current counter reading can be set within the defined value range.

5.6.3.2 Context menu numbering machine object

When a numbering machine object is inserted, the configuration corresponds to the presets. Each numbering machine object can be changed individually via the context menu.

- ▶ To open the context menu, right-click the desired numbering machine object.
The context menu opens as in the following figure:

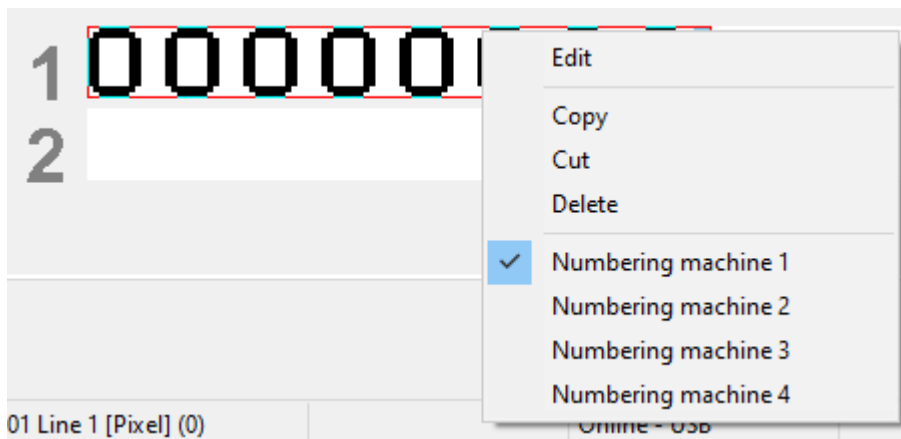

Function	Description
Edit	Opens the configuration window for the selected numbering machine object.
Copy	Copies the object.
Cut	Cuts out the object.
Delete	Deletes the object.
Numbering machine (1 to 4)	Select previously specified numbering machine (Tab File - Settings Date/Time - Numbering Machine).

6 Maintenance

[Changing the print cartridge](#)

[Cleaning the contacts of the print cartridge](#)

[Clean nozzles](#)

[Clean print carriage](#)

[Clean housing](#)

6.1 Changing the print cartridge

i When using special ink (MP), observe the notes in the operating instructions for the print cartridge.

CAUTION

Damage to health caused by ingestion of ink.

- ▶ Do not swallow!
- ▶ Keep the print cartridge out of the reach of children!

Changing the print cartridge ⇨ Fig. **C** + **D**

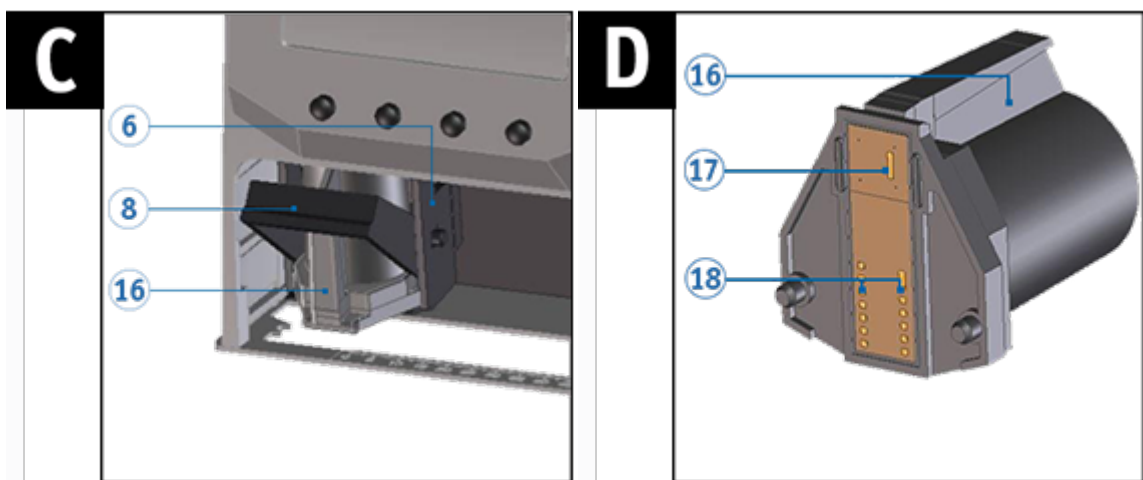

- ▶ Take the *jetStamp* 990 from the basis station **4**.
- ▶ Push [MENU] and browse ◀ ▶ until the display shows "Cartridge change start".
- ▶ Push [SELECT].
Print carriage moves to the device centre.
- ▶ Push the locking bracket **8** into the rear-most position.
- ▶ Take the print cartridge **7** from the print carriage **6**.
- ▶ Unpack the new print cartridge **7** and remove the protective film or clip.
(see operating instructions for the print cartridge P1).
- ▶ Insert the print cartridge into the print carriage **7** at the grip strip **16**.
Pull the locking bracket **8** forward again.
- ▶ Push [SELECT].
The print carriage moves to its basic position.
- ▶ In order to get right to the next menu item, push ◀ ▶.
- OR -
- ▶ To leave the main menu, push [RETURN].
The selected print image appears.

6.2 Cleaning the contacts of the print cartridge

Cleaning the contacts of the print cartridge ⇒ Fig. **A** + **C** + **D**

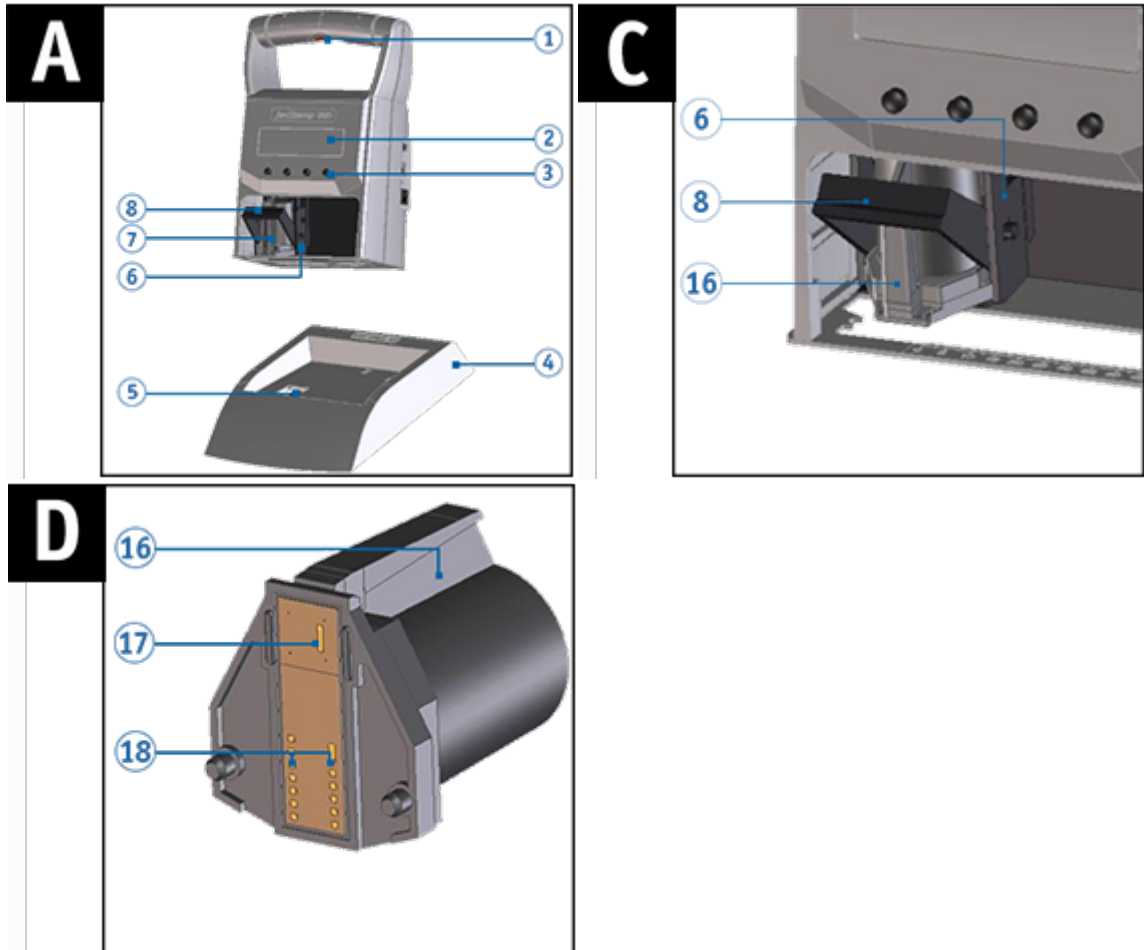

In rare cases, impurities on the contacts of the print cartridge **18** can cause incorrect printing results.

- ▶ Take the *jetStamp* 990 from the basis station **4**.
- ▶ Push [MENU] and browse ◀ ▶ until the display shows "Cartridge change start".
- ▶ Push [SELECT].
Print carriage moves to the device centre.
- ▶ Push the locking bracket **8** into the rear-most position.
- ▶ Remove the print cartridge **7** from the device.
- ▶ Clean the contacts of the print cartridge **18** at the print cartridge **7** and at the print carriage **6** with a soft cloth slightly soaked in ethanol (spirit) if necessary.
- ▶ Hold the print cartridge **7** by the grip strip **16** and insert it into the print carriage.
- ▶ Pull the locking bracket **8** forward again.
- ▶ Push [SELECT].
The print carriage moves to its basic position.

6.3 Clean nozzles

⚠ WARNING

Possible blindness due to eye contact with ink.

- ▶ Do not point the *jetStamp 990* nozzles **17** against people's faces!

If there are streaks in the imprint or problems with the print quality, the ink may have dried on the nozzles **17**.

[Manual nozzle cleaning](#)

6.3.1 Manual nozzle cleaning

Manual nozzle cleaning ⇔ Fig. **A** + **D**

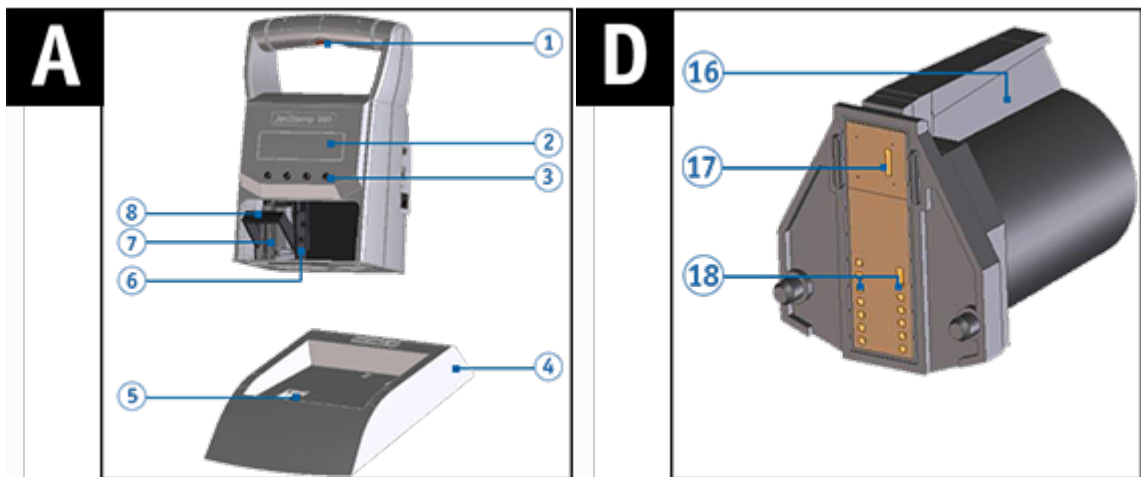

To ensure high print quality, the nozzles should **17** cleaned at regular intervals as follows:

- ▶ To dissolve the dried ink, press a soft cloth slightly soaked in ethanol (spirit) against the nozzles for about three **17** seconds.
- ▶ Dab off dissolved ink and **17** wipe the nozzles dry.

i For further information (also see "[Cleaning the contacts of the print cartridge](#)").

i For notes on temperatures and humidity, see "[Technical Data](#)" in the documents accompanying the print cartridges.

6.4 Clean print carriage

Ink and dried-in ink residues at the print carriage are removed with a soft spirit-soaked cleaning rag.

i On this, see also "[Cleaning contacts at the print cartridge](#)".

6.5 Clean housing

CAUTION

Electric shock when liquids enter into the device inside.

- ▶ Pull the mains adapter from the outlet.
- ▶ Inform a specialist vendor or the REINER service.

NOTICE

Cleaning agents that are too aggressive may damage the housing surface.

- ▶ Do not use any abrasives and plastic-dissolving cleaning agents for cleaning.
- ▶ Clean the top cover of the device with a soft cloth if required.
For stronger contamination, slightly moisten the cloth with water and mild detergent.

7 Recognising and removing interferences

[Operating modes and error messages](#)

7.1 Operating modes and error messages

Display	Cause	Correction
Imprint too long	Imprint too long	▶ In PCset: Change the imprint and send again.
Imprint wrong format	Imprint wrong format	▶ In PCset: Change the imprint and send again.
Cartridge missing	Cartridge missing	▶ Insert a cartridge.
Recharg. battery almost empty	Rechargeable battery almost empty	▶ Plug in power supply or USB and charge the batteries.
Bluetooth init failed	Bluetooth init failed	▶ Try again.
Print carriage movement blocked	Print carriage movement blocked	▶ Movement of print carriage stopped. Try again.
Bluetooth receive failed	Bluetooth receive failed	▶ Try again.
Device is locked	Device is locked	▶ Unlock the 990 (in menu).
Recharg. battery empty	Rechargeable battery empty	▶ Plug in power supply or USB and charge the batteries.
Recharg. battery missing	Rechargeable battery missing	▶ Use rechargeable batteries.
Recharg. battery defective	Rechargeable battery defective	▶ Use new rechargeable batteries.

8 Technical data and accessories

[Type plate](#)

[Technical data](#)

[Transport and disposal](#)

[Accessories](#)

8.1 Type plate

 Observe the type plate before the device is connected.

The type plate is located on the underside of the device.
It contains the following information:

Mod. = Model

No. = Item number

GEPR. = Test date



= *jetStamp* 990 has the CE-mark according to the currently valid low-voltage and EMC directive.



= *jetStamp* 990 is in accordance with the following standards or standardised documents
FCC 47 CFR Ch.1 Part 15 Bluetooth: FCC: R7TAMB2300.



= do not point the *jetStamp* 990 nozzles against people's faces!



Waste electrical and electronic devices

Old devices must not be disposed of in the common household waste but in a specified acceptance point for recycling of electrical and electronic devices.

8.2 Technical data

Technical data	
Dimensions stand-alone unit	101 x 81.45 x 158.95 mm (l x w x h)
Dimensions basis station	115.3 x 143.55 x 32.8 mm (l x w x h)
Total height	177.35 mm
Weight stand-alone unit	approx. 490 g
Weight basis station	approx. 250 g
Stamping time	< 1 second
Stamping sequence	> 5 seconds
Stamping sequence/bold print	> 6 seconds
Battery capacity	Ø 900 (min. 500) imprints
Printing technology	Inkjet
Ambience temperature for operation	10 °C ... +40 °C
Humidity for operation	10 % ... 80% relative humidity
Temperature for storage	
With standard print cartridges	10 °C ... +40 °C
With MP print cartridges	10 °C ... +20 °C
Storage humidity	10 % ... 80% relative humidity
With print cartridges	
Ambience temperature for transport	-20 °C ... 40 °C (up to 24 hours)
Humidity for transport	10 % ... 90 % relative humidity
Data transfer	USB, Bluetooth (optional)
Power supply	2 x AA NiMH rechargeable batteries; chargeable via included mains adapter. Input: 100-240VAC, 50-60Hz, 0.3A Output: 5VDC 1000mA
Standby time per battery charge	approx. 6 days
Battery charging time	approx. 3 hours
Print capacity per print cartridge	approx. 300,000 characters
Noise level	< 60dB (A) (work-related emission value purs. to ISO 7779)
Protection class	IP 20

8.3 Transport and disposal

Transport

NOTICE

Damage to the device at improper transport.

- ▶ Only use packaging that provides protection from impact and shock for the device!

Disposal



Defective or flat batteries

Used batteries or rechargeable batteries must not be disposed of with household waste.



Waste electrical and electronic devices

Old devices must not be disposed of in the common household waste but in a specified acceptance point for recycling of electrical and electronic devices.



8.4 Accessories

Inkjet print cartridge

- Order no.: 801 307 - 000, P1-S-BK (51604A-B) for paper and cardboard, black
- Order no.: 801 307 - 050, P1-S-RD (51605R-R) for paper and cardboard, red
- Order no.: 791 050 - 000, P1-EF-AUB for chicken eggs, aubergine
- Order no.: 791 050 - 001, P1-EF-RD for chicken eggs, red

Inkjet print cartridge (quick drying)

- Order no.: 791 060 - 000, P1-MP2-BK for metal and plastic, black
- Order no.: 791 060 - 030, P1-MP4-BK for glass, metal and plastic, black
- Order no.: 791 060 - 040, P1-MP6-YE for metal and plastic, yellow

For further accessories, see <https://www.reiner.de>

9 Contact

Ernst Reiner GmbH & Co. KG

Baumannstr. 16

78120 Furtwangen/Germany

www.reiner.de

Repair

Phone: +49 7723 657-385

Email: repair@reiner.de

More information on our homepage: www.reiner.de/repair

Technical Service & Support

Phone: +49 7723 657-388

Email: service@reiner.de

Sales

Phone: +49 7723 657-0

Email: customerservice@reiner.de

© 2020 Ernst Reiner GmbH & Co. KG

All rights reserved. Translation, reprint and other reproduction of these operating instructions, even in parts and no matter the form, shall require our express written consent. We reserve the right to make content changes to these operating instructions without notice.

10 Operating instructions

REINER*jetStamp 990*

Bedienungsanleitung

DE

Operating Manual

GB

Manual de instrucciones

ES

Mode d'emploi

FR

Index

- A -

Accessories 51
Activating Bluetooth 22

- B -

Bluetooth activate/deactivate 10

- C -

Cartridge change 10
Cartridge type 11
Change clock 10
Changing the print cartridge 44
Charge rechargeable batteries 18
Clean nozzles 46
Configuring the print image 32
Contact 52

- D -

Date/time
 Change clock 10
 Summertime 10
Device lock
 Activate/deactivate device lock 10
Device settings 28
Device settings date/time/numbering machine 28
Display and button functions 8
Double print 11

- E -

Establishing Bluetooth connection 31
Example workflow: Generating the print image 32
 Configuring the print image 32
 Printing the print image 33
 Transfer print image 32

- F -

Factory settings 11
File 28
Find REINER Bluetooth devices 28

Firmware update 24

- H -

Help 29

- I -

Info 29
Inserting rechargeable batteries 18
Inserting the print cartridge 20
Installing the REINER PCset software 24
Installing the software 24

- M -

Maintenance 43
 Clean housing 47
 Clean nozzles 46
 Clean print carriage 46
 Cleaning the contacts of the print cartridge 45
Manual nozzle cleaning 46
Menu bar
 Edit 27
 File 27
 Help 27
 Presettings 27
 View 27
Model version
 Software version 12

- N -

Numbering machine 39
Numbering machine (numbering machine 1 - 4) 11

- O -

Objects 30
Objects settings
 Date/Time 34
 Numbering machine 34, 39
 Text 34
Operating elements 6
Operating interface 27
 Menu bar 27
 Objects 30
 Toolbar 29
Operating modes and error messages 48
Overview of stored print images 22

- P -

Password change 11
Password menu 11
Preparing the jetStamp 990 for REINER PCset 26
Printing the print image 23, 33

- R -

Rechargeable batteries
 Reaching full capacity 13
 Recharging 13
Recognising and removing interferences 48

- S -

Safe handling of print cartridges 16
Safety notes 16
Safety notes on rechargeable batteries 15
Safety, description 14
Saved print images 21
Selecting print image 22
Setting Date/Clock Time 19
Setting summertime 19
Settings 11
Software version 12
Summertime 10

- T -

Technical data 50
Technical data and accessories 49
Text 34
Toolbar 29
Transfer print image 32
Transferring print images 28
Transport and disposal 51
Type plate 49

- U -

Uploading print images 28

- Y -

Your safety 14



REINER

www.reiner.de

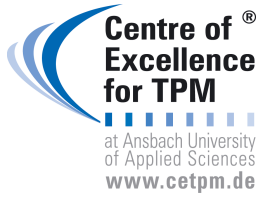

at Ansbach University
of Applied Sciences
www.cetpm.de

kiwa
geprüft & zertifiziert



QUALITÄTSMANAGEMENT